



Standard product reference sheet

MNU1109EAE-275-TR



Features

Package	Wide distribution angle, low power type Deep-UV LED (UVC) Peak wavelength 275nm Outer dimension 3.45 x 3.45 x 1.78mm(L x W x H)
Product features	<ul style="list-style-type: none">•Operating temperature : -40 to +60°C.•Total power : 3mW (Typ.) @ IF = 20mA•Lead-free soldering compliant•RoHS2 compliant

Recommended applications

Water/liquids disinfection : House water purifier, water purification devices, humidifier (water tank disinfection)

Surface disinfection : Small sterilizer, local sterilization unit

Inspection light sources : Light source for sensing device etc.



WARNING

- UV LEDs **emit high intensity UV (ultraviolet) light.**
- Do not look directly into the UV light source ; this can be harmful to your eyes and skin.**
- Wear protective eyewear to avoid exposure to UV light, as well as protective masks and gloves, etc. in order not to expose your skin to the light. Also take sufficient safety measures against light leakage, etc., in order to avoid any influence on the human body.
- Attach warning labels to your products which contain UV LEDs.
- keep out of reach of children.



Outline dimensions

MNU1109EAE-275-TR

Unit : mm
 Weight : 52.7mg
 Tolerance : ±0.2

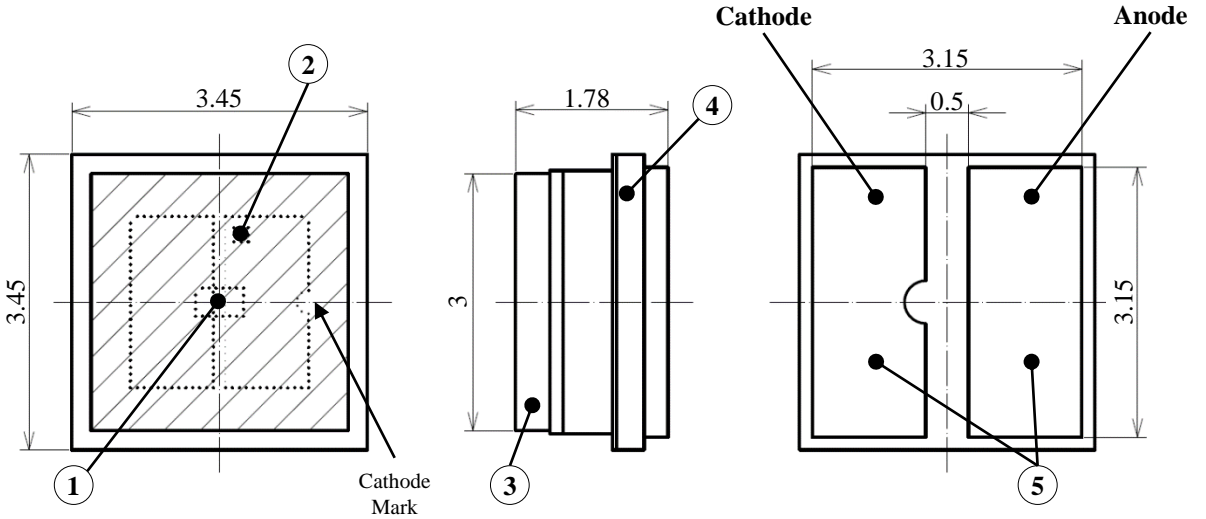

【 Internal circuit 】

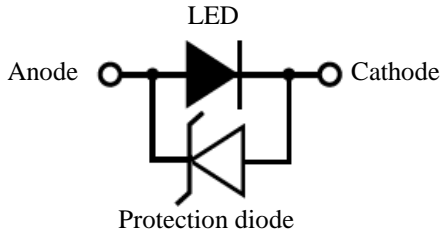

No.	Part name	Materials	Qty.
①	LED die	AlGaIn	1
②	Protection diode	Si	1
③	Sealing glass	Glass	1
④	Substrate	Ceramic	1
⑤	Electrode	Au plating	Anode : 1 Cathode : 1

Recommended pad

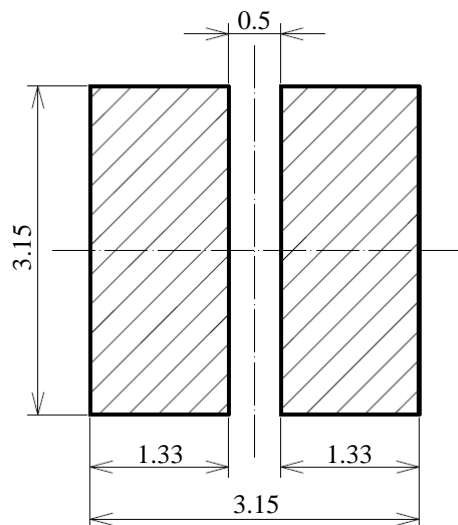

Unit : mm



Specifications

MNU1109EAE-275-TR

【 Product overview 】

Die material	AlGaN
Emitting color	Ultra violet

【 Absolute maximum ratings 】

Item	Symbol	Maximum ratings	Units	
Forward current	I_F	50	mA	Note 1
Operating temperature	T_{opr}	-40 to +60	°C	Note 2
Storage temperature	T_{stg}	-40 to +100	°C	Note 2
Electrostatic discharge threshold "HBM" ($T_a=25^{\circ}C$)	V_{ESD}	2	kV	Note 3
Junction temperature	T_j	85	°C	
Peak temperature of reflow soldering	T_{skd}	260	°C	

Note 1 Using the LED lamps with less than 1mA is not guaranteed.

Note 2 The ranges of operating and storage temperature are not applied to taping condition.

Note 3 ESD testing method : EIAJ4701/300(304) Human Body Model (HBM) 1.5kΩ,100pF

【 Thermal characteristics 】

($T_a=25^{\circ}C$)

Item	Symbol	Typ.	Max.	Units
Thermal resistance (Junction - Solder point)	$R_{th(j-s)}$	40.3	(43.0)	°C/W



Specifications

MNU1109EAE-275-TR

【 Electro-Optical characteristics 】

(Ta=25°C)

Item	Symbol	Conditions	Min.	Typ.	Max.	Units	
Total power	P _o	I _F = 20mA	1.8	3.0	4.2	mW	Note 4
Peak wavelength	λ _p	I _F = 20mA	265	275	285	nm	Note 5
Spectral half width	Δλ	I _F = 20mA	-	10	-	nm	
Half intensity angle	2θ _{1/2}	-	-	120	-	deg.	
Forward voltage	V _F	I _F = 20mA	4.0	5.2	6.5	V	Note 6

Note 4 Total Power is measured by integrating sphere, and the Tolerance is ±10%.

Note 5 Peak Wavelength Tolerance is ±3nm.

Note 6 Forward Voltage Tolerance is ±3%.

【 Sorting chart for total power 】

LEDs shall be sorted out "Total power" into the following chart and each rank parts shall be packed separately when shipping.

Rank	Total power (mW)		Conditions
	Min.	Max.	
A	1.8	2.3	I _F = 20mA Ta = 25°C
B	2.3	2.8	
C	2.8	3.3	
D	3.3	3.8	
E	3.8	4.2	

Notes Measurement tolerance: ±10%

【 Sorting chart for forward voltage 】

LEDs shall be sorted out "Forward voltage" into the following chart.

Each rank parts shall be packed separately when shipping.

Rank	Forward voltage(V)		Conditions
	Min.	Max.	
A	4.0	4.5	I _F = 20mA Ta = 25°C
B	4.5	5.0	
C	5.0	5.5	
D	5.5	6.5	

Notes Measurement tolerance: ±3%

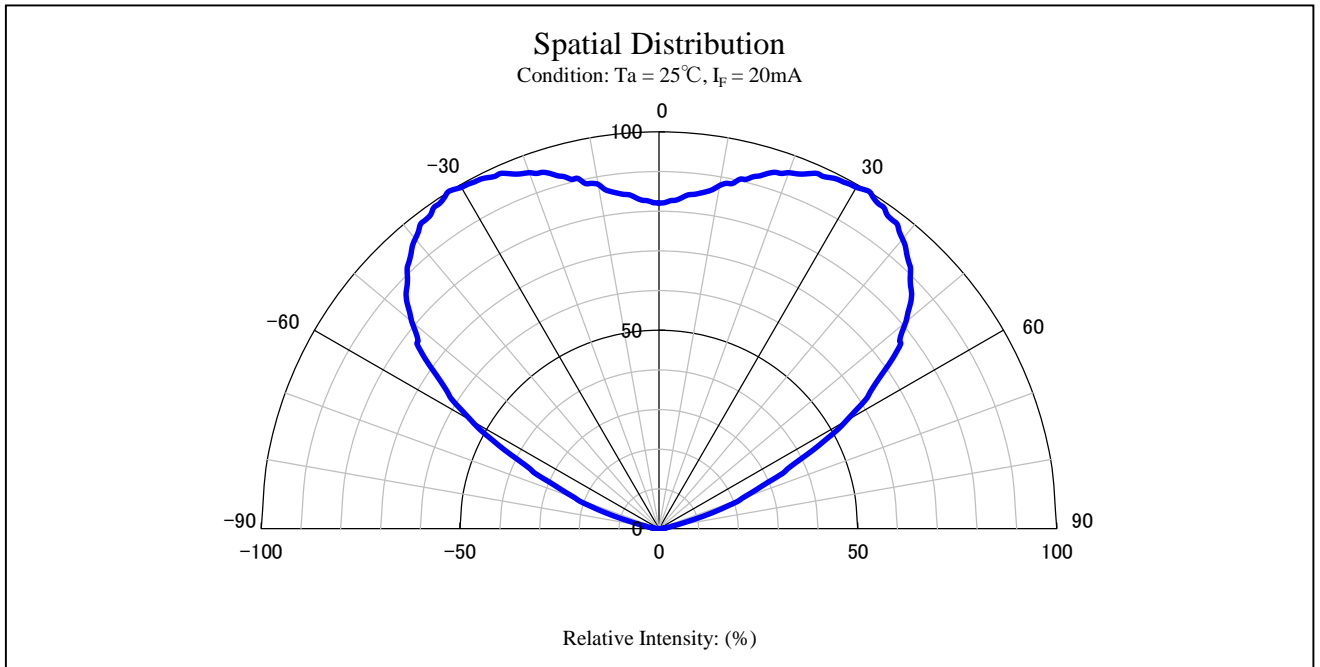
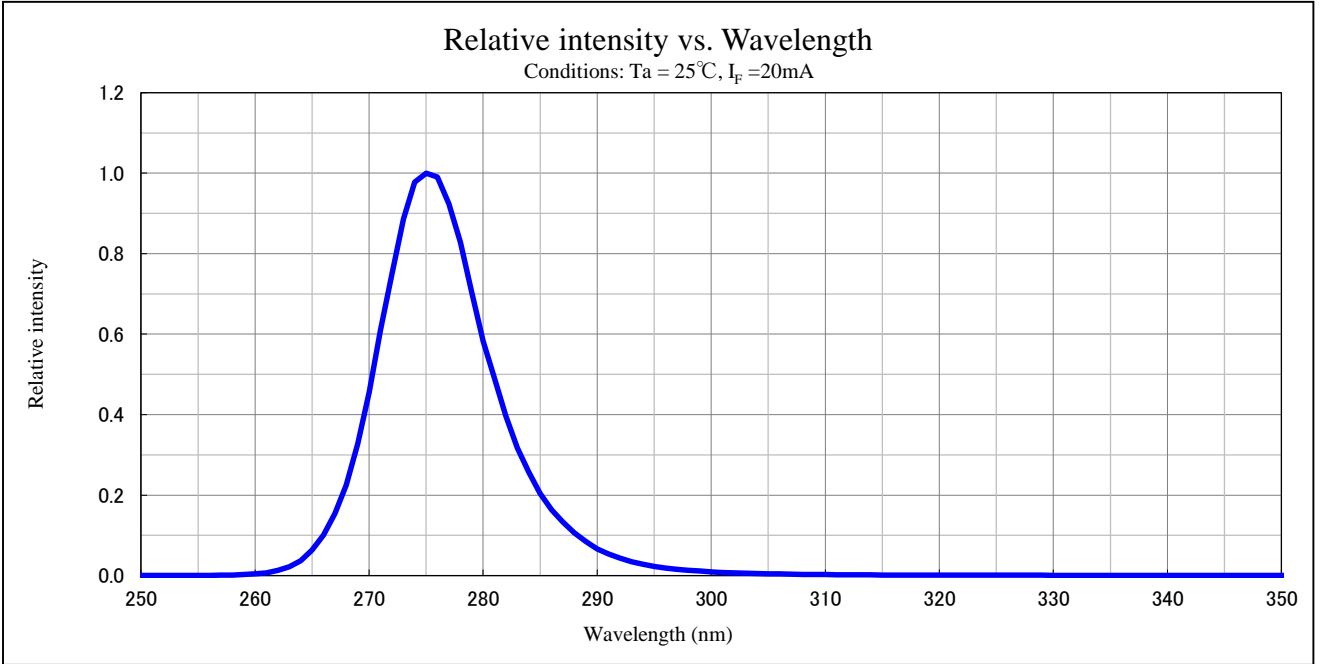



Technical data

MNU1109EAE-275-TR

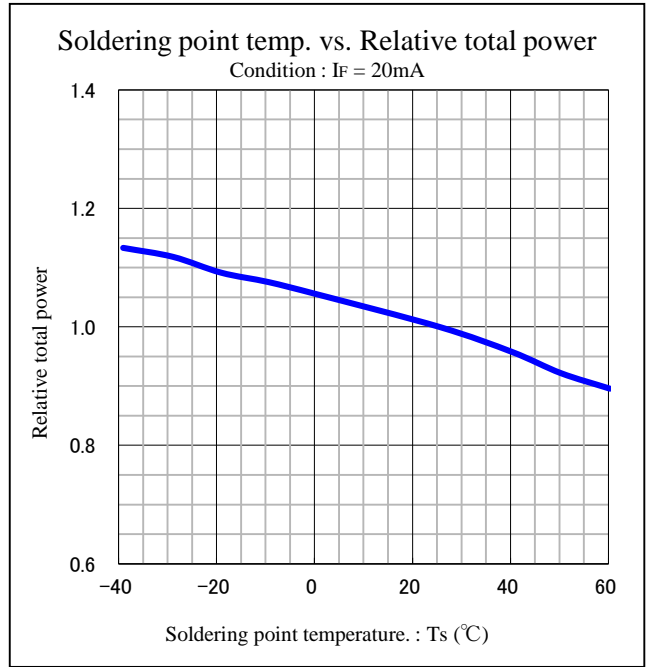
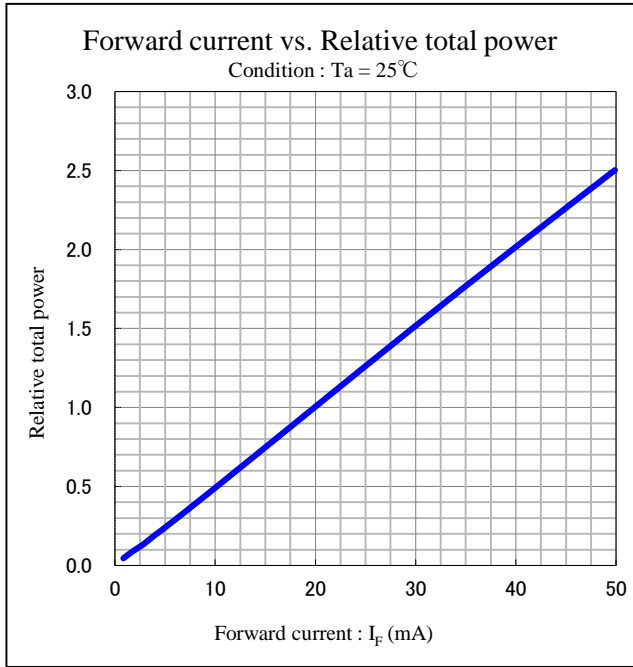
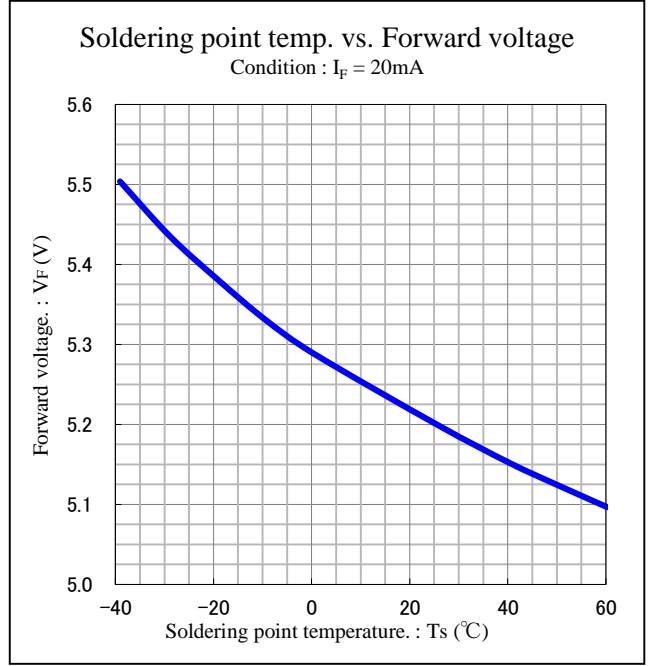
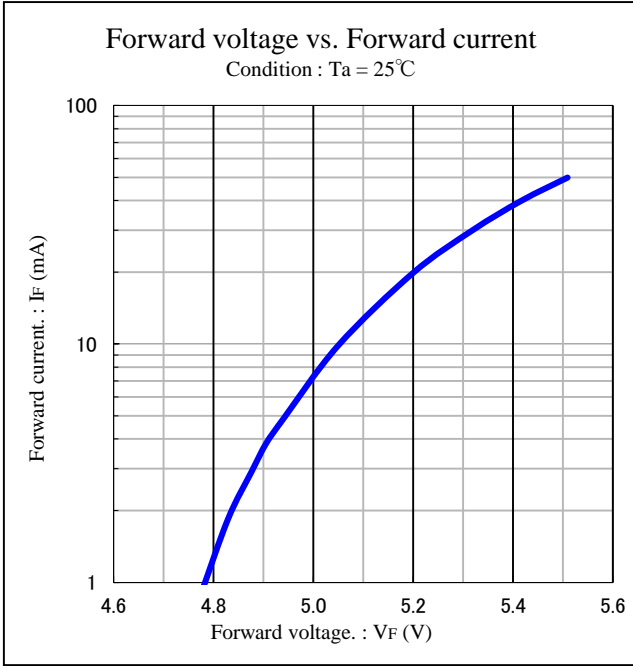



Technical data

MNU1109EAE-275-TR

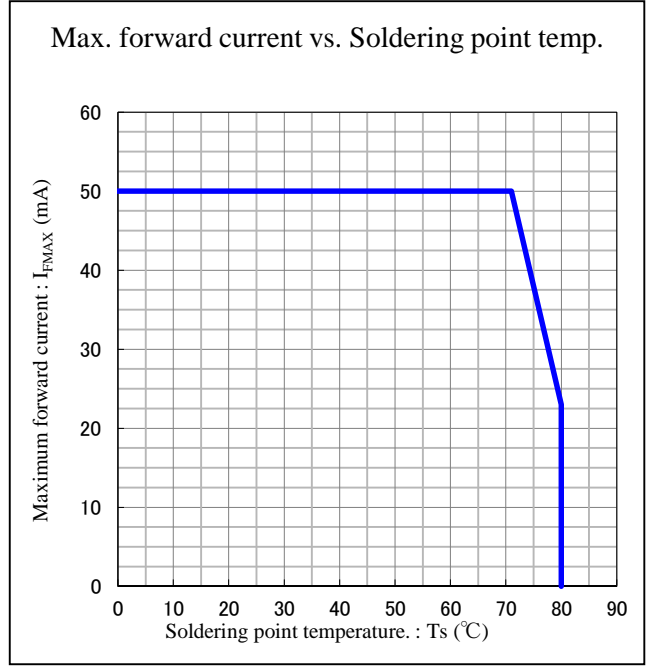
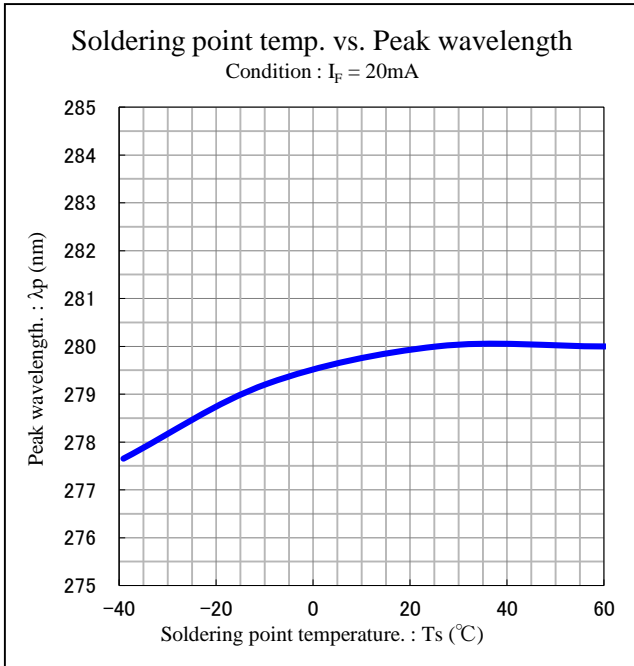



Soldering condition

MNU1109EAE-275-TR

【Soldering Precaution】

(acc.to EIAJ-4701/300)

1. Heat stress during soldering will influence the reliability of LEDs, however that effect will vary on heating method. Also, if components of varying shape are soldered together, it is recommended to set the soldering pad temperature according to the component most vulnerable to heat (e.g., surface mount LED).
2. LED parts including the resin are not stable immediately after soldering (when they are not at room temperature), any mechanical stress may cause damage to the product. Please avoid such stress after soldering, especially stacking of the boards which may cause the boards to warp and any other types of friction with hard materials.
3. Recommended temperature profile for the Reflow soldering is listed as the temperature of the resin surface. Temperature distribution varies on heating method, PCB material, other components in the assembly, and mounting density.
Typically, when FR-4 PCB is mounted with one LED and heated via far infrared and hot air, the difference in temperature between PCB and LED resin will be around 5 to 10°C.
Please do not repeat the heating process in Reflow process more than twice.

【Recommended Reflow Soldering Condition】

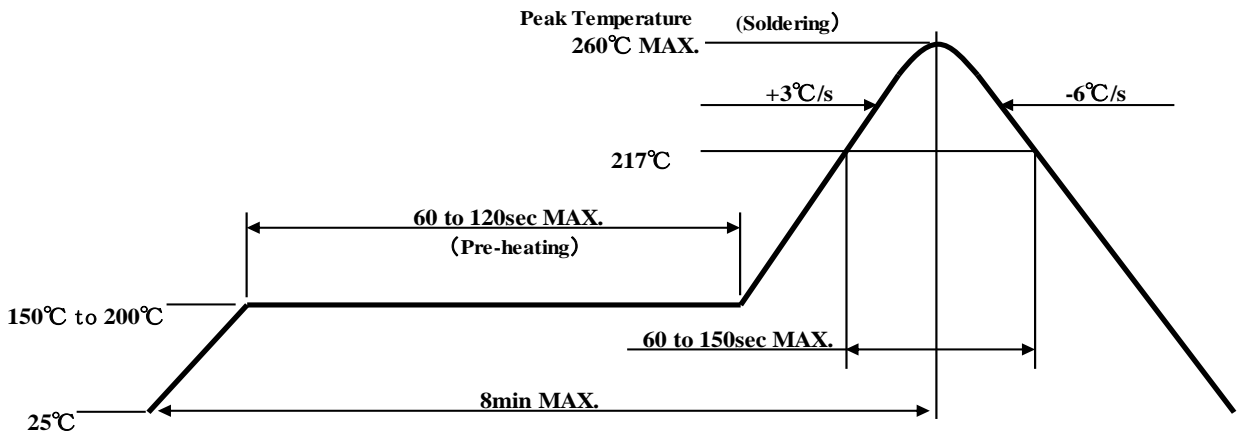

- Note 1 Temperature Profile for the reflow should be set to the surface temperature of resin which is on the top of LED. This should be the maximum temperature for soldering. Lowering the heating temperature and decreasing heating time is very effective in achieving higher reliability.
- Note 2 The reflow soldering process should be done up to twice (2 times Max). When second process is performed, interval between first and second process should be as short as possible to prevent absorption of moisture to resin of LED. The second soldering process should not be done until LEDs have returned to room temperature (by nature-cooling) after first soldering process.



Soldering condition

MNU1109EAE-275-TR

4. When using a metal PCB, the solder may crack and problems may occur due to major stress on the soldered portion caused by thermal shock. Please carry out a thorough advance verification before use. For the metal PCB's insulation, it is recommended to use stress-reducing materials.
5. Manual soldering and flow soldering (dip soldering) are not recommended for this product.
6. Isopropyl alcohol is recommended for cleaning. Some chemicals, including Freon substitute detergent could corrode the lens or the casing surface, which cause discoloration, cloud, crack and so on. Please review the reference chart below for cleaning. If water is used to clean (including the final cleaning process), please use pure water (not tap water), and completely dry the component. Cleaning with ultrasonic is not recommended.

Cleaning agents	Recommended / Not recommended
Isopropyl alcohol	✓ Recommended
Ethyl alcohol	✓ Recommended
Pure water	✓ Recommended
Trichloroethylene	x Not recommended
Chloroethene	x Not recommended
Acetone	x Not recommended
Thinner	x Not recommended



Handling precaution

MNU1109EAE-275-TR

【For Electric Static Discharge (ESD)】

This type of LED lamp is highly sensitive to surge voltage generated by the On/Off status change and discharges of static electricity through frictions with synthetic materials, which may cause severe damage to the die or undermine its reliability. Damaged products may experience conditions such as extremely high reverse voltage, or a decrease of forward rise voltage, deteriorating its optical characteristic. Stanley products are packed with anti-static components. However, the following precautions and measures are vital in ensuring product quality during shipment.

1. Electrification/Static Electricity protection

Stanley recommends the following precautions in order to avoid product (die) damage from static electricity, when an operator and other materials electrified by friction coming in contact with the product.

- ① Do not place electrified non-conductive materials near the LED product.
Avoid LED products from coming into contact with metallic materials.(Should the metallic material be electrified, the sudden surge voltage will most likely damage the product.)
- ② Avoid a working process which may cause the LED product to rub against other materials.
- ③ Install ground wires for any equipment, where they can be installed, with measures to avoid static electricity surges.
- ④ Prepare a ESD protective area by placing a Conductive Mattress (1MΩ MAX.) and Ionizer to remove any static electricity.
- ⑤ Operators should wear a protective wrist-strap.
- ⑥ Operators should wear conductive work-clothes and shoes.
- ⑦ To handle the products directly, Stanley recommends the use of ceramic, and not metallic, tweezers.

2. Working Environment

- ① A dry environment is more likely to cause static electricity. Although a dry environment is ideal for storage state of LED products, Stanley recommends an environment with approximately 50% humidity after the soldering process.
- ② Recommended static electricity level in the working environment is 150V, which is the same value as Integrated Circuits (which are sensitive to static electricity).



Handling precaution

MNU1109EAE-275-TR

【Other precautions】

1. Stanley LED Lamps have semiconductor characteristics and are designed to ensure high reliability. However, the performance may vary depending on usage conditions.
2. Absolute Maximum Ratings are set to prevent LED lamps from failing due to excess stress(temperature, current, voltage, etc.). Usage conditions must not exceed the ratings for a moment, nor do reach one item of absolute maximum ratings simultaneously.
3. In order to ensure high reliability from LED Lamps, variable factors that arise in actual usage conditions should be taken into account for designing. (Derating of TYP., MAX Forward Voltage, etc.)
4. Please insert Straight Protective Resistors into the circuit in order to stabilize LED operation and to prevent the device from igniting due to excess current.
5. Please avoid to using the products with materials and products that contain sulfur and chlorine elements because the reliability may be decreased. Please keep in desiccator before and after mounting, to prevent the products from being affected by corrosive gas. Also please make sure there isn't any gas in the surrounding area or entering from outside when using the products.
6. Please check the actual life time performance in the assembly at your company because the Specification Sheets are described for one single LED.
7. When there is a process of supersonic wave welding etc. after mounting the product, there is a possibility of affecting on the reliability of junction part in package (junction part of die bonding and wire bonding). Please make sure there is no problem before using.
8. The products are designed to perform without failure in the recommended usage conditions. However, please take the necessary precautions to prevent fire, injury, and other damage from these unexpected failures.
9. The products are manufactured to be used for ordinary electronic equipment. Please contact our sales staff in advance when exceptional quality and reliability are required, when the failure or malfunction of the products might directly jeopardize life or health (such as for airplanes, aerospace, medical applications, nuclear reactor control systems and so on).
10. Please avoid overload to the product when using tweezers to pick up LEDs. Overload might cause deformation, disconnection, chip-outs and consequently lead to lighting failure. Tweezers with flat tips is recommended, please avoid using tweezers with sharp tips.
11. Pay attention to handling and storage of LEDs even after mounting, because overload caused by stacking PCBs and shock due to dropping and crashing might also lead to deformation, disconnection, and chip-outs.
12. In the processes of water pressure during cleaning, air pressure, drying and other processes after mounting, overload to glass should be avoided.
13. The edge of glass is sharp. Please do not handle the LEDs with hands directly to avoid injury. Also, please do not touch the glass surface, the contamination of glass can affect the optical characteristics.
14. Please adjust the load, the pick up point, the nozzle diameter and etc. before mounting because the over load can cause the breakage of the glass. (Recommend load condition : Less than 5N)



Handling precaution

MNU1109EAE-275-TR

【Other precautions】

15. This product belongs to **risk group "3"** in the Photobiological Safety of Lamps and Lamp Systems Standard (IEC62471), which indicates potential risk of damage to eyes and skin due to ultraviolet radiations.
Risk group 3 is classified as "high" concerning potential hazards to the human body; it is the highest risk group "that causes damage even from temporary or short exposure to ultraviolet radiations". Safety precautions are required.
16. This product emits strong ultraviolet rays when it is lit up.
Please do not look directly into the light source, for it could damage your eyes.
Should it be necessary to observe the product while it is being lit, **always use protective glasses that cut ultraviolet rays, as well as protective masks and gloves, etc. in order not to expose your skin to the light.**
Please also take sufficient safety measures against light leakage, etc., in order to avoid any influence on the human body.
17. Attach caution labels to your products which contain UV LEDs.
18. Keep out of reach of children.
19. The formal specification sheets should be exchanged and signed by both parties.



Packaging specifications

MNU1109EAE-275-TR

This product is shipped in moisture-proof packaging (as shown below) to minimize moisture absorption during shipping. However, in regards to storing the products, the use of dry-box under the following conditions is recommended. Moisture-proof bag as the packaging is made of anti-static material but packaging box is not.

【Recommended storage condition / Products warranty period】

Temperature	+5 to 30°C
Humidity	Under 60%rh

In the case of the package unopened , **12 months under 【 Recommended storage condition 】**. Please avoid rapid transition from low temp. condition to high temp. condition and storage in corroding and dusty environment.

【Time elapsed after package opening】

This product is **equivalent to IPC/JEDEC J-STD-020D MSL 3**. (168h = a week)

The package should not be opened until immediately prior to its use.

If any components should remain after their use, please seal the package and store them under the conditions described in the above 【 Recommended storage condition 】.

Baking process should be performed after putting out from package.

Please keep the time frame between package opening and soldering which is **【maximum 672h.】**

Baking conditions: **24h(min.), at +60°C ±5°C** just before use

Baking may be performed in the tape-reel form, however if it is performed with the reel stacked over one another, it may cause deformation of the reels and taping materials, which may cause problems during production. Please make sure that the product has cooled to normal temperature after performing the baking process. Provided that, baking process shall be 2 times Max.

【Products warrant period】

In the case of the package unopened , 1 year under 【 Recommended Storage Condition 】.

Please avoid rapid transition from low temp. condition to high temp. condition.



Packaging specifications

MNU1109EAE-275-TR

【Moisture-proof packaging specification】

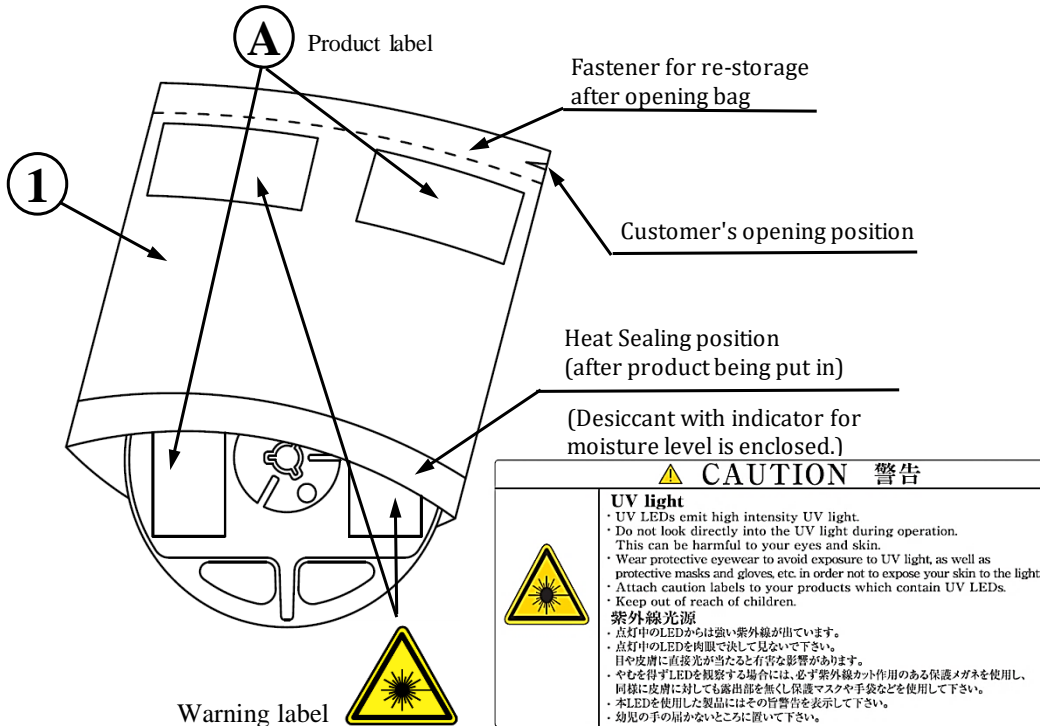

No.	Part name	Material	Remarks
①	Moisture-proof bag with aluminum layer	PET+Al+PE	with ESD protection

【Flow chart-package opening to mounting】

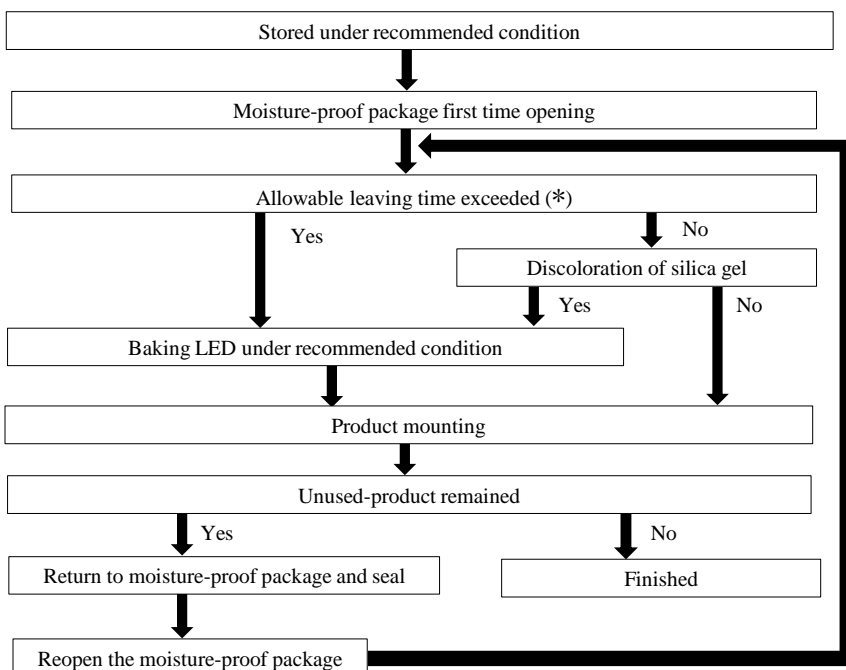

Allowable leaving time means the maximum allowable leaving time after opening package, which depends on each LED type.

The allowable leaving time should be calculated from the first opening of package to the time when soldering process is finished.

When judging if the allowable leaving time has exceeded or not, please subtract the soldering time after reopening. The allowable leaving time after reopening should be calculated from the first opening of package, or from the time when baking process is finished.



Packaging specifications

MNU1109EAE-275-TR

【Packing box】

(RoHS2 / ELV Compliant)

Box type	Outline dimension L x W x H (mm)	Capacity of the box
Type A	280 x 265 x 45 (mm)	2 reels
Type B	310 x 235 x 265 (mm)	10 reels
Type C	440 x 310 x 265 (mm)	20 reels

The above measures are all the reference values.

The box is selected out of the above table by shipping quantity.

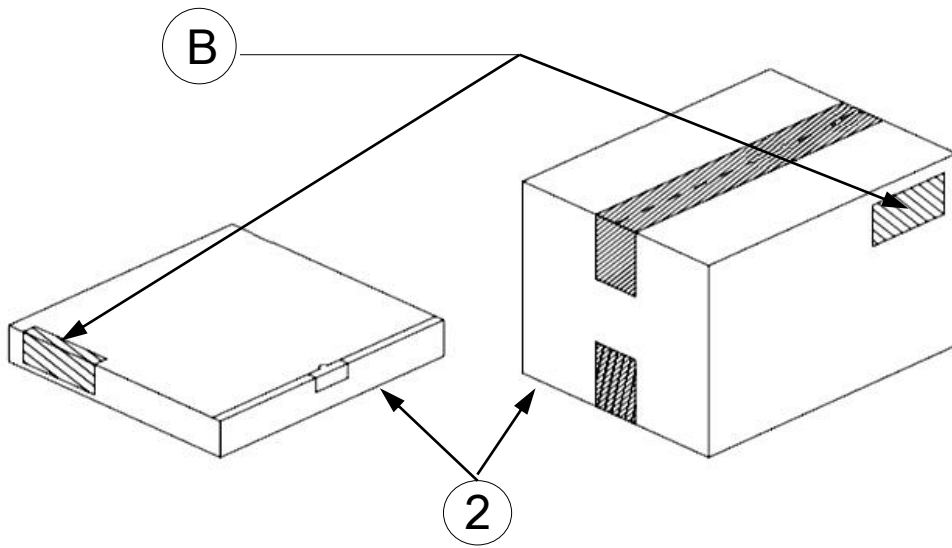

Type A

Material / box : Cardboard C5BF

Type B,C

Material / box : Cardboard K5AF

Partition : Cardboard K5AF

NO.	PART NAME	MATERIAL	REMARKS
②	Packing box	Corrugated cardboard	without ESD protection



Packaging specifications

MNU1109EAE-275-TR

【Label specification】

(acc.to JIS-X0503(Code-39))

A Product label

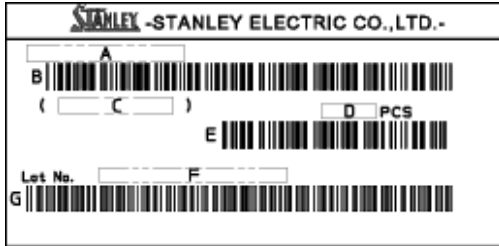

- A. Parts number
- B. Bar-code for parts number
- C. Parts code (In-house identification code for each parts number)
- D. Packed parts quantity
- E. Bar-Code for packed parts quantity
- F. Lot number & Rank
(refer to Lot Number Notational System for details)
- G. Bar-Code for Lot number & Rank

B Opto device label

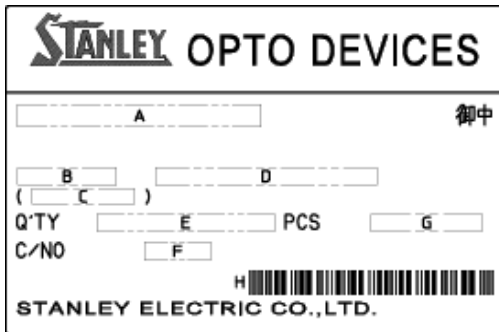

- A. Customer Name
- B. Parts Type
- C. Parts Code
- D. Parts Number
- E. Packed Parts Quantity
- F. Carton Number
- G. Shipping Date
- H. Bar-Code for In-house identification Number

<Remarks> Bar-code font : acc.to Code-39(JIS-X0503)



Taping and reel specifications

MNU1109EAE-275-TR

【Appearance】

(acc.to JIS-C0806)

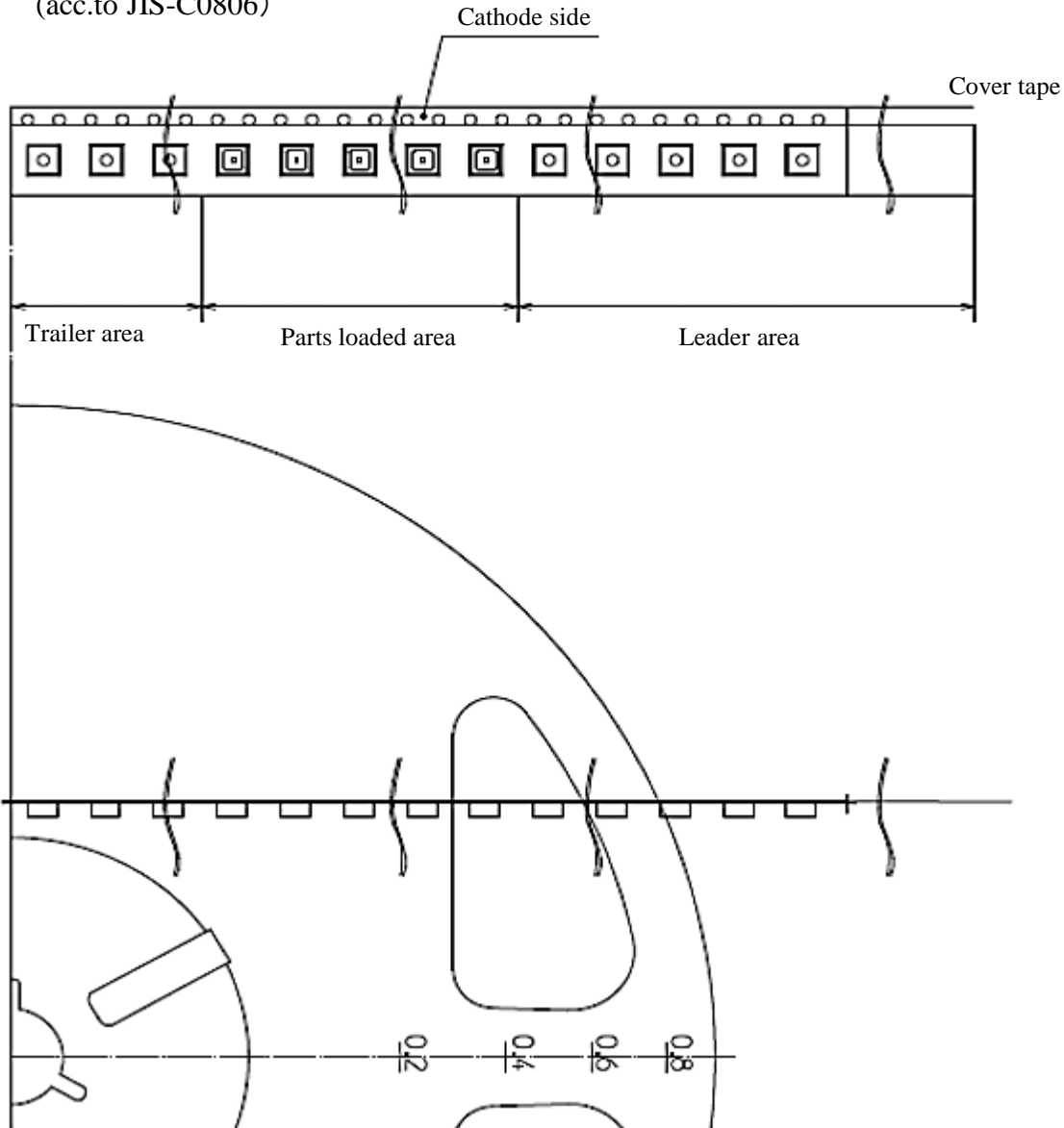

Note

"-TR" means Cathode Side of LEDs should be placed on the sprocket-hole side.

Items		Specifications	Remarks
Leader area	Cover-tape	Cover-tape shall be longer than 300mm without carrier-tape.	The end of cover-tape shall be held with adhesive tape.
	Carrier-tape	Empty pocket shall be more than 13 pieces. (longer than 100mm)	Please refer to the above figure for Taping & reel orientation .
Trailer area		Empty pocket shall be more than 20 pieces. (longer than 160mm)	The end of taping shall be inserted into a slit of the hub.



Taping and reel specifications

MNU1109EAE-275-TR

(acc.to JIS-C0806-03)

【Qty. per reel】

500parts/reel

Minimum Qty. per reel might be 100 parts when getting less than 500 parts. In such case, parts of 5-unit-qty. shall be packed in a reel and the qty. shall be identified on the label.

【Mechanical strength】

Cover-tape adhesive strength shall be 0.1~1.0N (an angle between carrier-tape and cover-tape shall be 170 deg.) Both tapes shall be so sealed that the contained parts will not come out from the tape when it is bent at a radius of 15mm.

【Others】

Reversed-orientation, Up-side down placing, side placing and out of spec. parts mixing shall not be held. Empty pocket per reel is assumed until 1 piece.



Lot number notational system

MNU1109EAE-275-TR

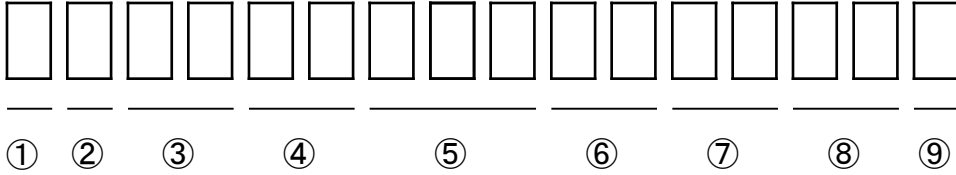

① - 1digit : Production location (mark identify alphabet)

② - 1digit : Production year (The last digit of production year 2020→0, 2021→1, 2022→2, 2023→3 …)

③ - 2digits : Production month (Jan. to Sep. , should be 01,02,03 …)

④ - 2digits : Production date

⑤ - 3digits : Serial number

⑥ - 2digits : Tape and reel following number

⑦ - 2digits : Total power rank.

(If total power rank is 1 digit, "-" shall be dashed on the place for the second digit.

If there is no identified rank, "- -" is used to indicate.)

⑧ - 2digits : Wavelength rank

(If wavelength rank is 1 digit, "-" shall be dashed on the place for the second digit.

If there is no identified rank, "- -" is used to indicate.)

⑨ - 1digit : VF Rank (If rank is not defined, "-" is described.)



Correspondence to RoHS2 / ELV instruction

MNU1109EAE-275-TR

This product is in compliance with RoHS2/ ELV.

Prohibition substance and its criteria value of RoHS2/ ELV are as follows.

- RoHS2 instruction ... Refer to following 1 to 10.
- ELV instruction ... Refer to following 1 to 4.

No.	Substances	Threshold
1	Lead and its compounds	0.1% (1,000ppm)
2	Mercury and its compounds	0.1% (1,000ppm)
3	Cadmium and its compounds	0.01% (100ppm)
4	Hexavalent chromium compounds	0.1% (1,000ppm)
5	PBB : Polybrominated Biphenyls	0.1% (1,000ppm)
6	PBDE : Polybrominated Biphenyl Ethers	0.1% (1,000ppm)
7	DEHP : Bis (2-ethylhexyl) phthalate	0.1% (1,000ppm)
8	BBP : Butyl benzyl phthalate	0.1% (1,000ppm)
9	DBP : Dibutyl phthalate	0.1% (1,000ppm)
10	DIBP : Diisobutyl phthalate	0.1% (1,000ppm)



Reliability testing result

MNU1109EAE-275-TR

Test Item	Standard	Test Condition	Duration	Failure
Room Temperature Operating Life	EIAJ ED-4701 /100(101)	Ta=25°C I _F =20mA	1,000h	0 / 10
Wet High Temperature Operating Life	EIAJ ED-4701 /100(102)	Ta=60°C Rh=90% I _F =20mA	1,000h	0 / 10
Thermal Shock	EIAJ ED-4701 /100(105)	Ta=-30°C to 100°C (each 15min)	100 cycles	0 / 10

Failure criteria

Item	Symbol	Condition	Failure criteria
Total power	P _O	I _F =20mA	Testing min. value < Standard min. value × 0.4
Forward voltage	V _F	I _F =20mA	Testing max. value ≥ Standard max. value × 1.1
Cosmetic appearance	-	-	Remarkable discoloration, deformation and cracking



Special notice to customers using the products and technical information shown in this data sheet

- 1) The technical information shown in the data sheets are limited to the typical characteristics and circuit examples of the referenced products. It does not constitute the warranting of industrial property nor the granting of any license.
- 2) For the purpose of product improvement, the specifications, characteristics and technical data described in the data sheets are subject to change without prior notice. Therefore it is recommended that the most updated specifications be used in your design.
- 3) When using the products described in the data sheets, please adhere to the maximum ratings for operating voltage, heat dissipation characteristics, and other precautions for use. We are not responsible for any damage which may occur if these specifications are exceeded.
- 4) The products that have been described to this catalog are manufactured so that they will be used for the electrical instrument of the benchmark (OA equipment, telecommunications equipment, AV machine, home appliance and measuring instrument).
The application of aircrafts, space borne application, medical equipment and nuclear power control equipment, etc. needs a high reliability and safety, and the breakdown and the wrong operation might influence the life or the human body. Please consult us beforehand if you plan to use our product for the usages of aircrafts, space borne application, transportation equipment, medical equipment and nuclear power control equipment, etc. except OA equipment, telecommunications equipment, AV machine, home appliance and measuring instrument.
- 5) In order to export the products or technologies described in this data sheet which are under the “Foreign Exchange and Foreign Trade Control Law,” it is necessary to first obtain an export permit from the Japanese government.
- 6) No part of this data sheet may be reprinted or reproduced without prior written permission from Stanley Electric Co., Ltd.
- 7) The most updated edition of this data sheet can be obtained from the address below:
<https://www.stanley-components.com/en/>



WARNING

- UV LEDs **emit high intensity UV (ultraviolet) light.**
- **Do not look directly into the UV light source ; this can be harmful to your eyes and skin.**
- **Wear protective eyewear to avoid exposure to UV light, as well as protective masks and gloves, etc. in order not to expose your skin to the light. Also take sufficient safety measures against light leakage, etc., in order to avoid any influence on the human body.**
- **Attach warning labels to your products which contain UV LEDs.**
- **keep out of reach of children.**