

Surface-Mount Reflector Sensor

KU163 is a compact surface-mount package that incorporates an infrared LED and phototransistor. By using a phototransistor to detect the reflection of light emitted from an LED, it can detect objects near the surface of the device. As it uses the reflection of light, it can also detect the speed of a rotary object. This report explains KU163 as a masterpiece.

Structure

Fig. 1 shows the structure of KU163. The infrared LED and phototransistor are positioned on either side of a central light shield. When the LED emits light, the light shield prevents the light from passing through the device and reaching the phototransistor. However, because it cannot completely block out incident light that passes through the device, product specifications provide a leakage current value. When creating an applied design of KU163, it is important to understand the coupling characteristics of the LED and phototransistor, but it is just as important to know their respective characteristics.

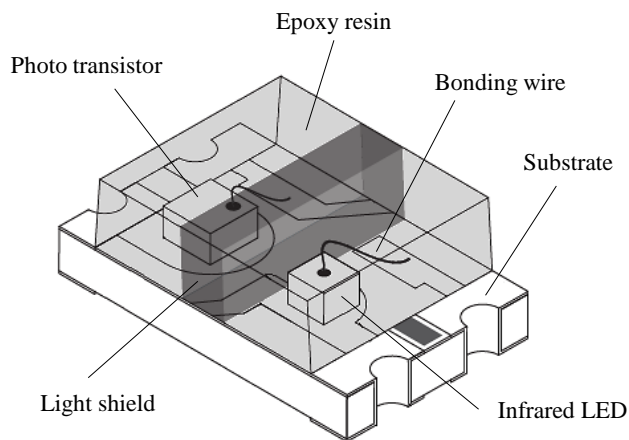

Fig.1 Structure of KU163

Various characteristics

Infrared LED Characteristics

The LED die used in KU163 is an infrared LED that has a peak emission wavelength of around 940 to 950nm. Such LEDs are frequently used to provide light in the remote controllers of home electronics. Infrared LEDs are a solid-state light-emitting device, and have a long lifespan similar to visible LEDs used in indicators. Most LEDs are compound semiconductors with characteristics that change according to the surrounding temperature.

Fig. 2 shows relative output characteristics in relation to ambient temperature, and Fig.3 shows forward voltage characteristics also in relation to ambient temperature. Forward voltage and output both have a negative characteristic with respect to ambient temperature.

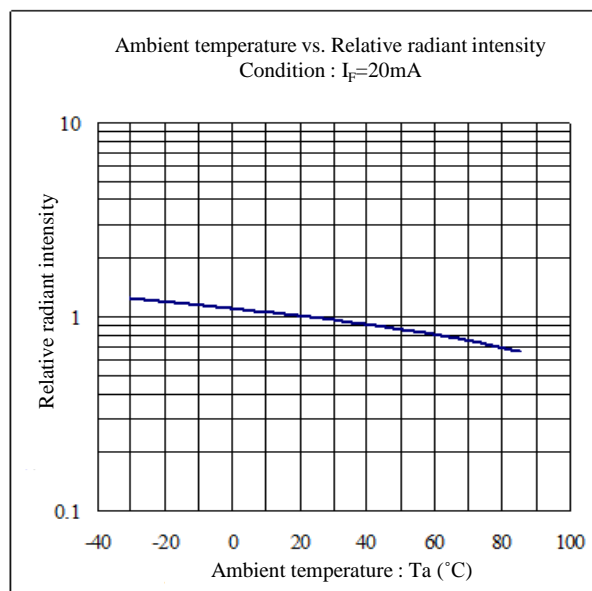

Fig.2 Output characteristics of KU163/infrared LED

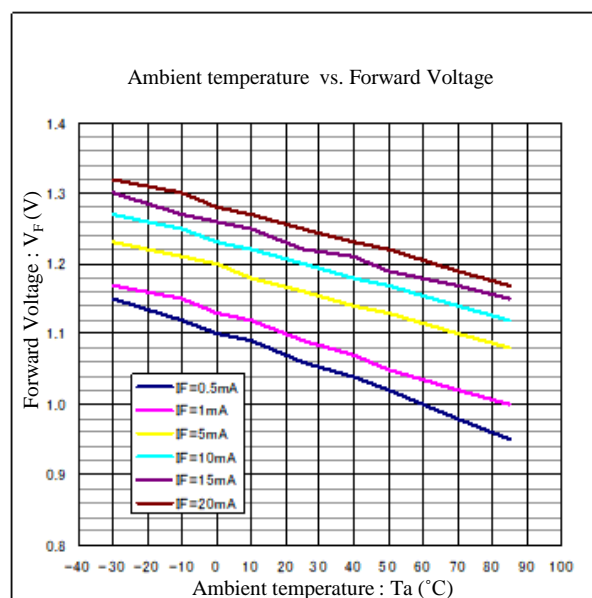

Fig.3 Forward voltage characteristics of KU163 /infrared LED

Fig.2 shows relative output characteristics in relation to ambient temperature, and Fig.3 shows forward voltage characteristics also in relation to ambient temperature. Forward voltage and output both have a negative characteristic with respect to ambient temperature. Also, the maximum amount of forward current that can be applied according to ambient temperature is generally regulated, dependent on the allowable power loss of the package. Fig.4 shows the derating characteristics of the LED incorporated in KU163. It shows that it is necessary to restrict maximum forward current in accordance with the maximum operating temperature of the product that uses KU163. In the graph, forward current is restricted to 10mA at KU163's peak operating temperature of 85°C.

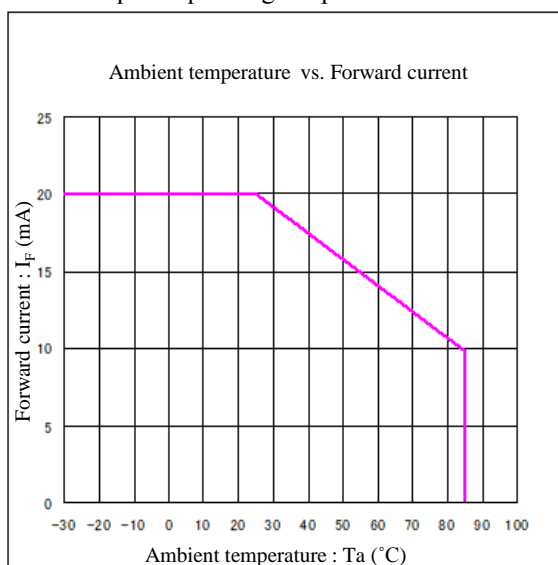

Fig.4 Derating characteristics of KU163/infrared LED

Phototransistor Characteristics

The phototransistor, like the LED, is a semiconductor device, but it is a silicon-based semiconductor that has the function of converting light to electric current, which is the opposite of the function of an LED. It is an die that amplifies the photocurrent generated by a photodiode using the amplification function of a transistor. The photocurrent created by incident light in a phototransistor corresponds to the base current in a normal transistor. Therefore, a phototransistor is able to generate a large photocurrent, although at response speeds slower than a photodiode. The spectral sensitivity of a phototransistor is characterized by a wider wavelength sensitivity compared to an LED, so that the phototransistor is sensitive not only to the infrared region by also to the visible light region. Although its peak sensitivity wavelength differs from an LED's peak emission wavelength, its wide wavelength sensitivity dispels any problem in its usage. In KU163, sensitivity in the visible light region is reduced by molding the package in a resin that acts as a filter and shuts out visible light.

Fig.5 shows dark current characteristics. Dark current is a current that is generated in a completely dark state, and has the temperature characteristics shown in Fig.5. Fig.6 shows the temperature characteristics of a photo current. The photo current also has temperature characteristics.

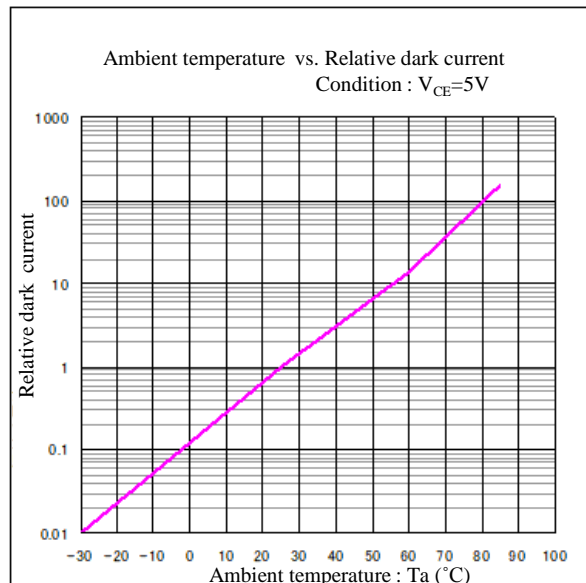

Fig.5 Dark current temperature characteristics of KU163/phototransistor

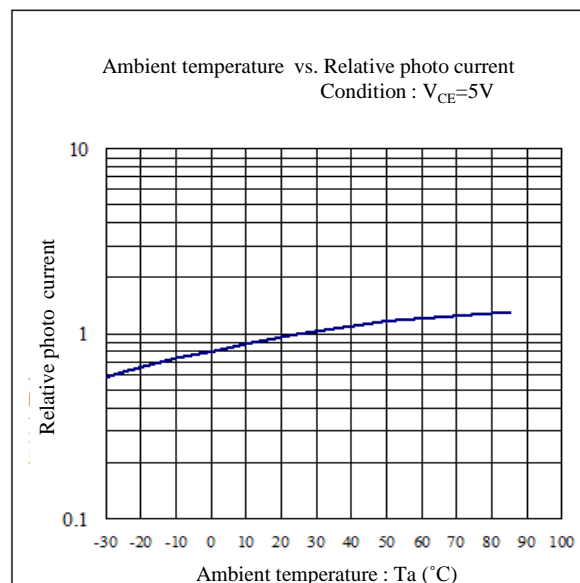

Fig.6 Photo current characteristics of KU163/phototransistor

As shown above, the LED and phototransistor both have temperature characteristics, so when designing an application, it is important to consider the operating environment and ambient temperature.

Coupling Characteristics as a Reflector Sensor

This section discusses the total characteristics of the LED and phototransistor in KU163 in relation to the coupling of their respective dies. In KU163, light emitted by the LED inside the device is prevented from reaching the phototransistor as incident light by a light shield, but a small amount of light nevertheless leaks and generates a photo current. Fig.7 shows the temperature characteristics of the leak current when a 5mA constant current is applied to the LED

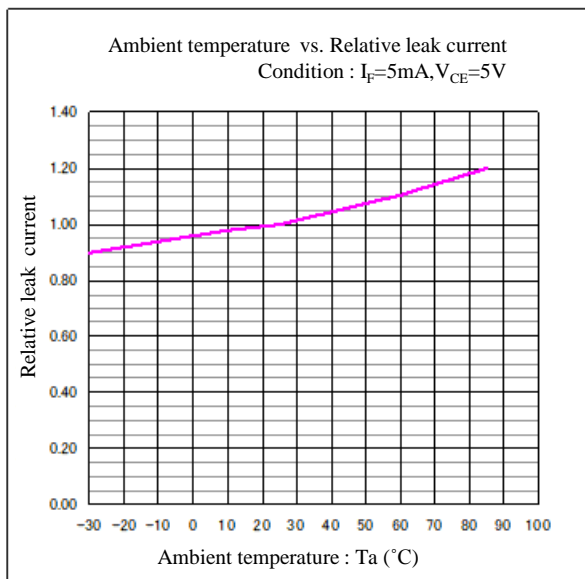

Fig.7 KU163 leak current characteristic

Fig.8 shows the photo current characteristic of KU163. It is the temperature characteristic of a photocurrent output when a 5mA constant current is applied to the LED side and the distance to the aluminum mirror is set to 1mm. It shows the combined temperature characteristics of the LED and phototransistor. Note that the photo current output characteristic includes both the dark current and leak current characteristics.

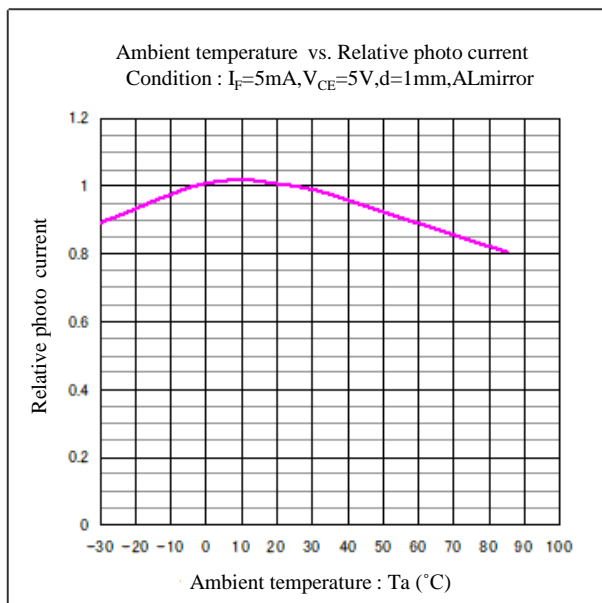

Fig.8 KU163 photocurrent characteristic

The characteristics of KU163 as a reflector sensor are as follows. The photo current of the phototransistor is dependent on the reflectivity of the item it detects. Fig. 9 shows the relationship between distance and photo current, relative to the value of 1 for the amount of photo current that can be obtained with the aluminum mirror positioned 1 mm from the top surface of KU163. The parameters are the reflectivity of detection objects. The graph shows the photo currents that are obtained when changing the distance between KU163 and the detection object, relative to the value of 1 for amount of photo current that can be obtained from the detection object by the aluminum mirror when a constant current of 5mA is applied to the LED.

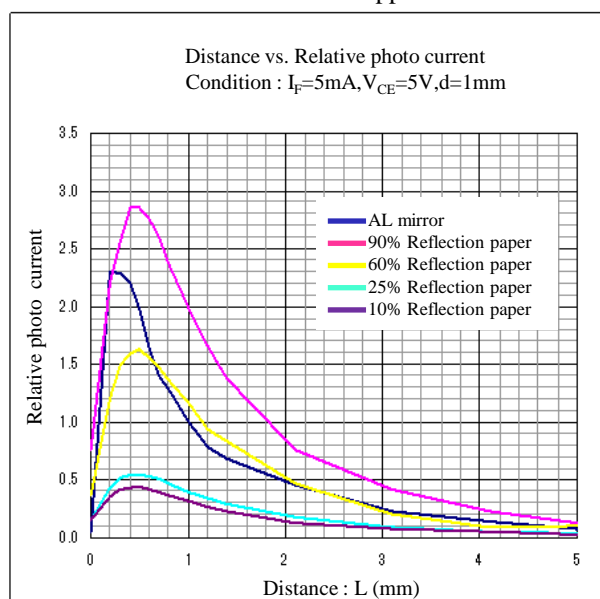

Fig.9 KU163 distance vs. photocurrent characteristic

The above is the coupling characteristics of KU163. As can be seen in Fig.9, the photo current that can be obtained greatly varies according to the detection object. For example, a sheet of paper with a 90% reflectivity can provide a larger photo current compared to an aluminum mirror.

Applied Design

This section introduces design examples that take the above characteristics into consideration. As shown in Fig.10, suppose KU163 is used to detect the speed of an object moving in a certain direction at a distance of 1 mm from the surface of the device. A coating of paint with high reflectivity (say 90%) is applied to the detection object at uniform intervals, and the areas between the painted parts have low reflectivity (say 20%). KU163 is used in the circuit shown in Fig.11, so that the photo current output is converted to voltage at the point of load resistance R_L . The output is converted to logic level, and the pulse edge timing is measured at the microcontroller using a timer and converted to speed Fig.12.

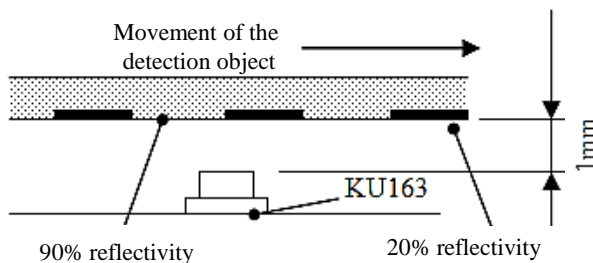

Fig.10 Application example

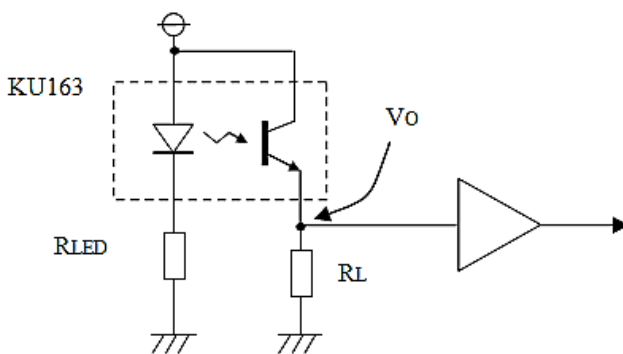

Fig.11 Applied circuit example

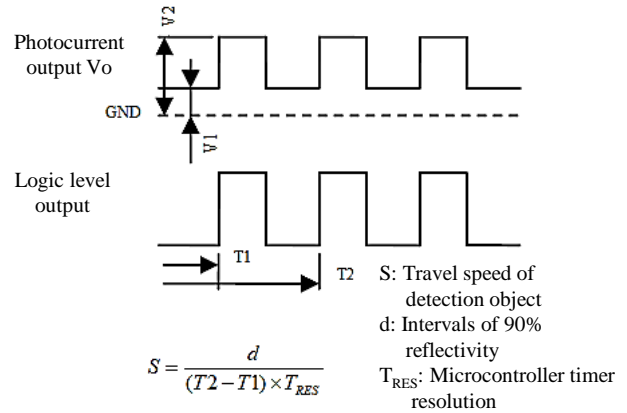

Fig.12 Speed detection

Other operating conditions are as follows.

Power supply voltage: 5V

Operating temperature range: -30°C to $+60^{\circ}\text{C}$

The operating current of the KU163 LED shall be 5mA. The results of a circuit driven by load resistance (R_{LED}) as shown in Fig.11 can be expected to change under the above-mentioned conditions, but in order to focus on the output of the phototransistor, the temperature requirement shall be set at room temperature (25°C). R_{LED} can be calculated using the following formula.

$$R_{LED} = (5 - 1.1) / 0.005 = 780[\Omega]$$

The V_F of the LED is calculated using the Typ. value listed in the production specification.

From the characteristics of KU163 (Fig.9) and the Typ. value in the production specification, the following output voltages (V_O) can be expected.

Output voltage when reflectivity is 90%

$$V_1 = 2 \times 300[\mu\text{A}] \times R_L$$

Output voltage when reflectivity is 20%

$$V_2 = 0.6 \times 300[\mu\text{A}] \times R_L$$

Output (V_O) is connected to the logic IC, so load resistance (R_L) is set to match the input conditions on the logic circuit side. Firstly it is matched to the CMOS level. When input at the CMOS level is the general requirement, power supply voltage is 5V, so the voltages at the H level and L level are calculated as follows.

$$\text{H level} : 0.7 \times V_{dd} = 3.5[\text{V}]$$

$$\text{L level} : 0.2 \times V_{dd} = 1.0[\text{V}]$$

Under the H level requirement, R_L is calculated as follows.

$$R_L = \frac{3.5[\text{V}]}{2 \times 300[\mu\text{A}]} = 5.8[\text{k}\Omega]$$

The output voltage at the L level When R_L is the above value, the output voltage at the L level is calculated as follows.

$$V_2 = 5.8[\text{k}\Omega] \times 0.6 \times 300[\mu\text{A}] = 1.044[\text{V}]$$

V_2 becomes 1.044V, which means that CMOS logic cannot be driven stably even without factoring in the design margin. Beside CMOS, connection to a TTL level logic could also be considered. Since the H level must be over 2.0V and the L level must be below 0.8V, when $R_L = 3.3\text{k}\Omega$, V_1 and V_2 become 2.16V and 0.65V, respectively, making it possible to connect directly to the logic circuit. However, because the TTL itself requires an operating current capability, it is not suitable for connection to a phototransistor output. We recommend using a CMOS type buffer that is compatible with a TTL logic level. Fig.13 shows a circuit that has been improved to drive a logic circuit by using a comparator to set a reference voltage, instead of the logic circuit directly receiving the output. Phototransistors are readily influenced by ambient light such as surrounding lighting fixtures and sunlight depending on the usage environment. Therefore, in an environment subject to the incident of ambient light, photo currents from ambient light are added to the output of photo currents generated by signals from reflected light. When receiving output at the logic level, a voltage that lies between the H and L levels could be output, depending on certain conditions. Employing a circuit like the one shown in Fig.13 would ensure the most stable operation.

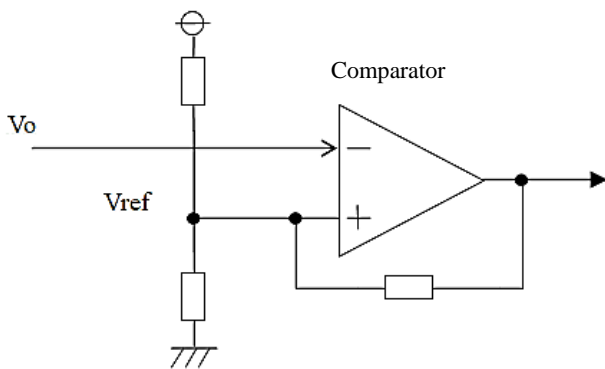

Fig.13 Comparator circuit

AC operations under the above-mentioned usage conditions can be considered as follows. A phototransistor has a junction capacitive component, which determines the response time limit together with load resistance (R_L). Fig.14 is a graph that shows this characteristic. It shows that when $V_{CE} = 5\text{V}$ and R_L is $3.3\text{k}\Omega$, rise time is $30\mu\text{s}$ and fall time is $40\mu\text{s}$.

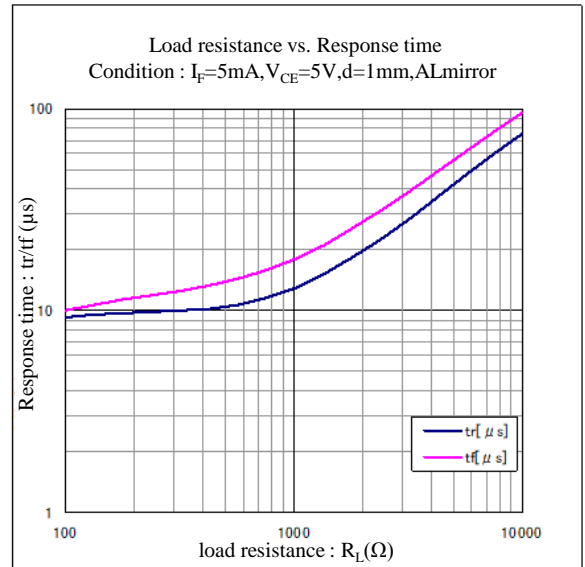

Fig.14 KU163 response characteristic

Expression of relations of the general frequency band and response time.

$$B_w \times T = 0.35$$

B_w : Frequency bandwidth (cutoff frequency)

T : Response time

When $T = 40\mu\text{s}$ is substituted into the following general relational equation of frequency bandwidth and response time, cutoff frequency can be calculated as $8.75[\text{kHz}]$. This means that, in Fig.10, the sensor can detect speeds of up to $8,750\text{cm/sec}$ when paint with 90% reflectivity occurs at 1cm intervals.